

KARTY PRACY

MIĘDZYNARODOWY DZIEŃ PUZZLI

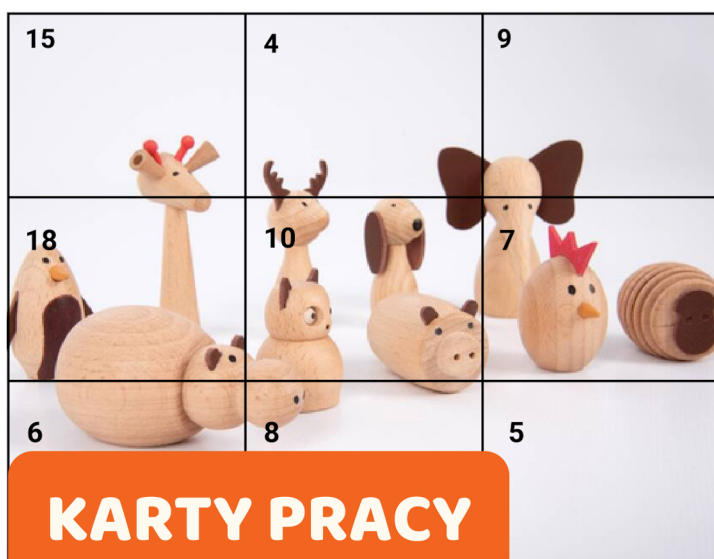

KARTY PRACY

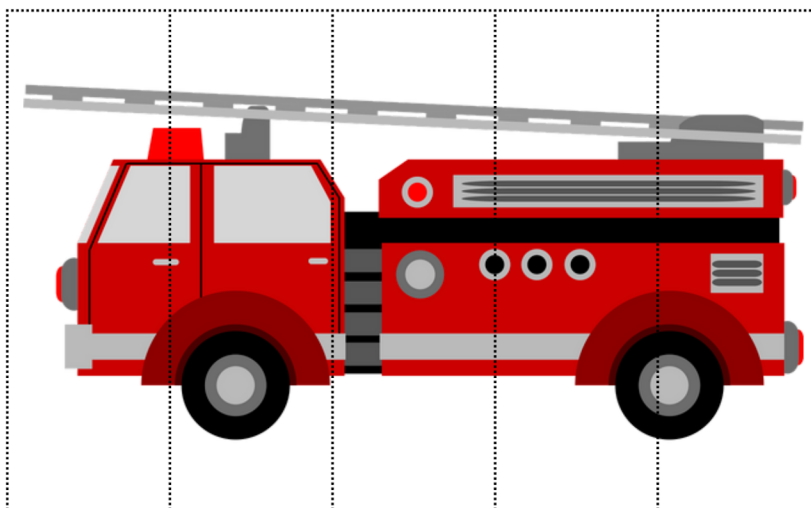
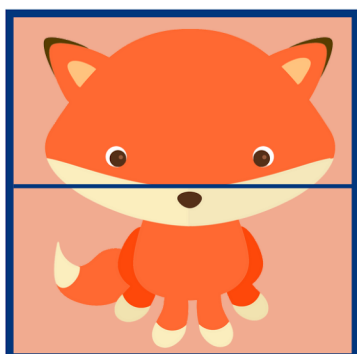
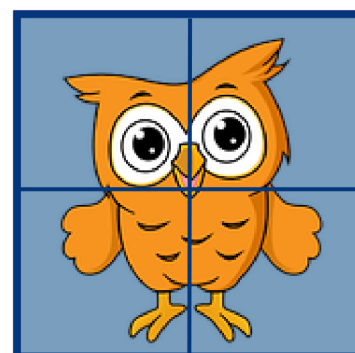

Puzzle dla najmłodszych

Wydrukuj, wytnij, zalaminuj i baw się!



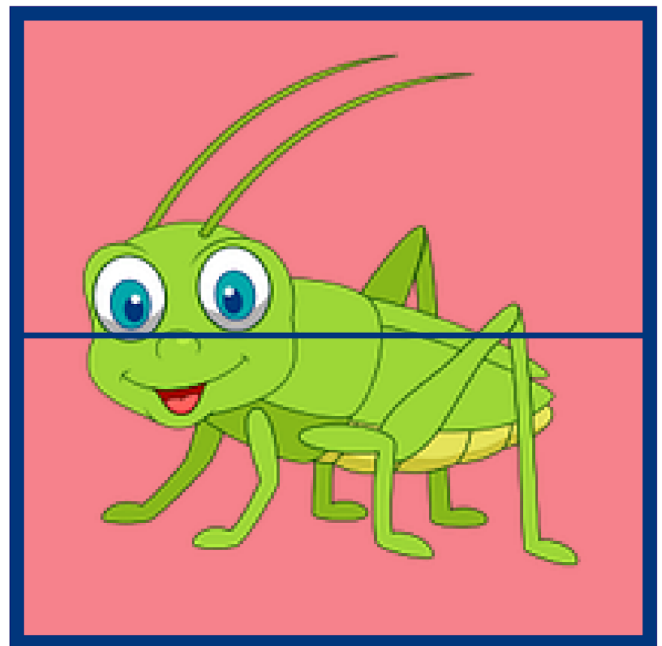
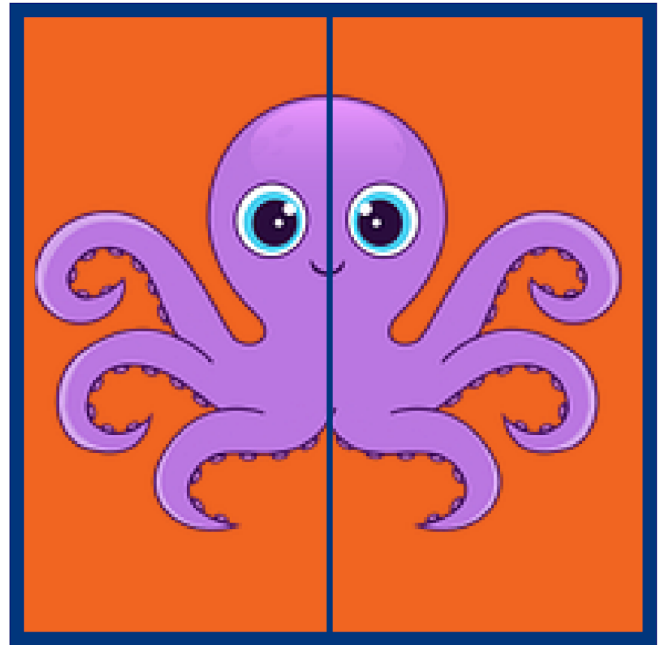

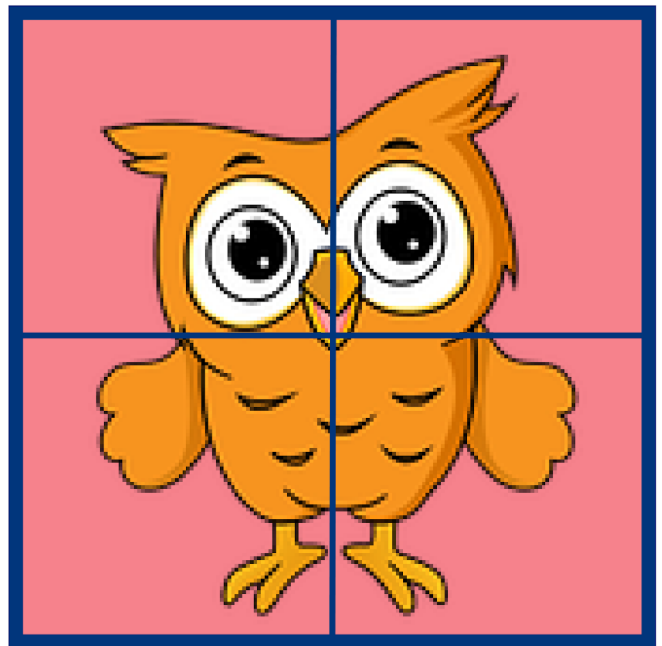
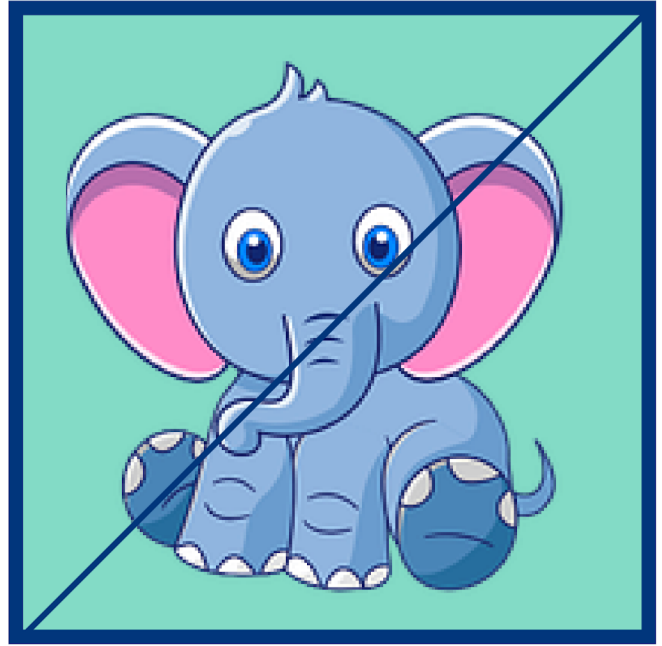
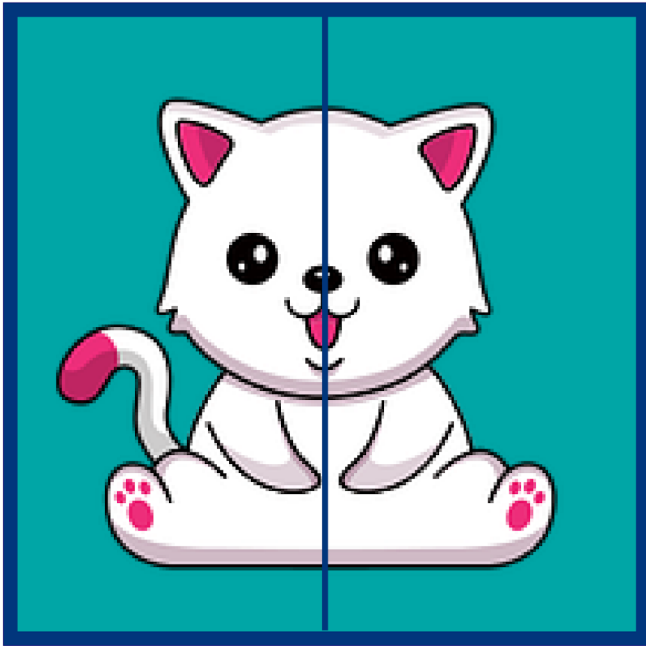

Wytnij kolorowy obrazek i złącz
w całość według wzoru

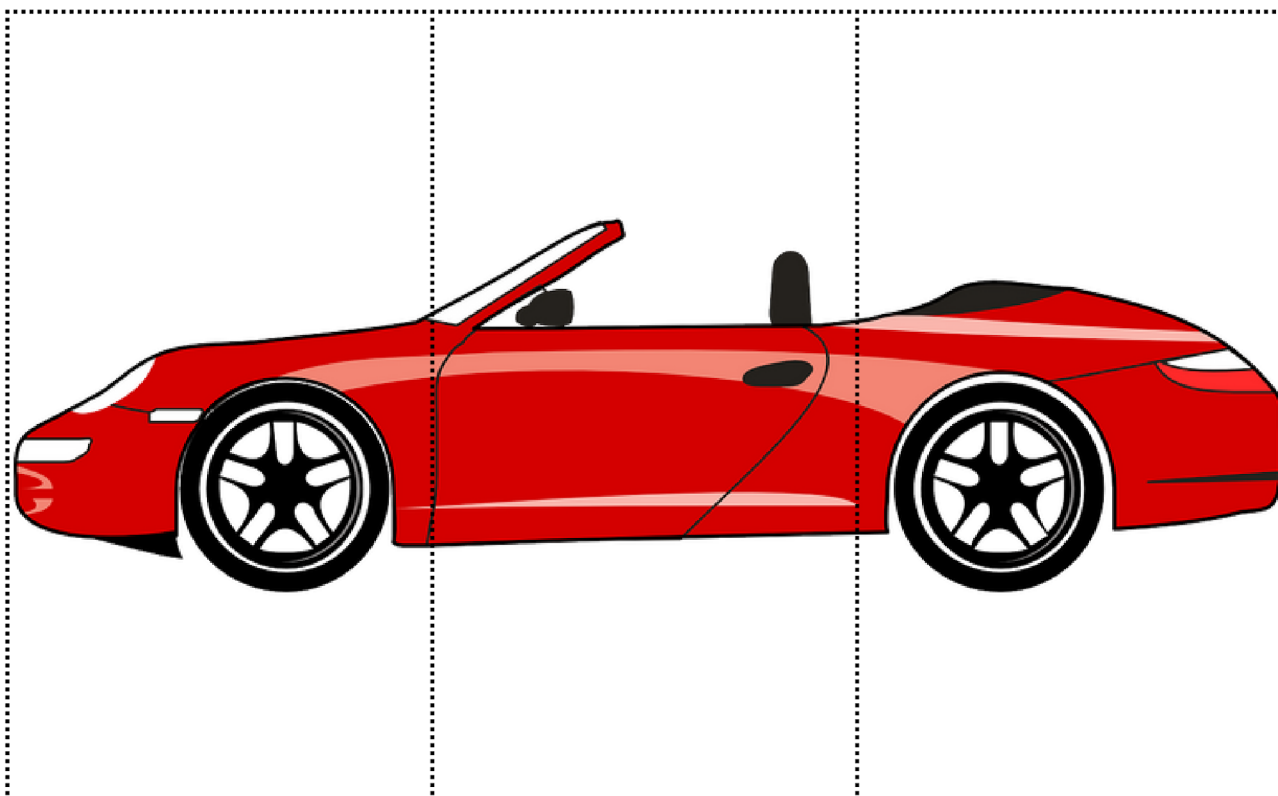
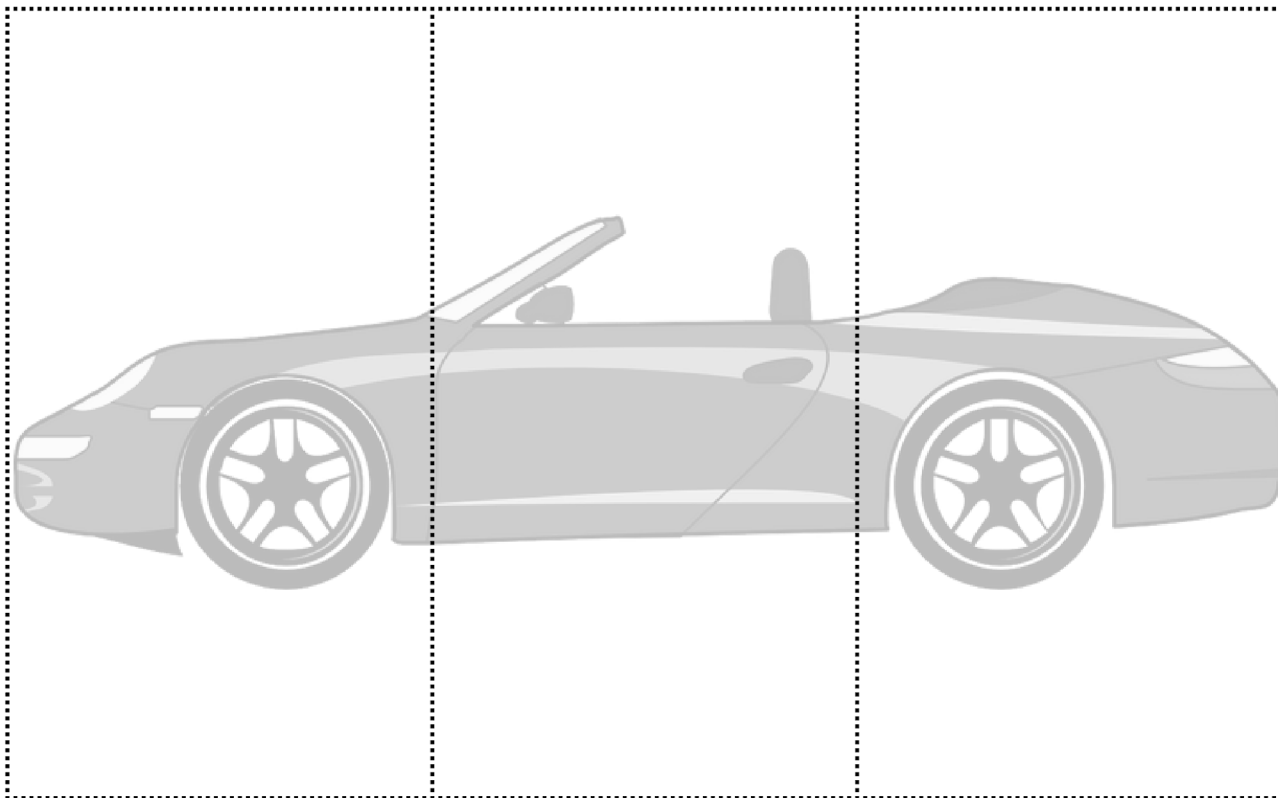

Wytnij kolorowy obrazek i złącz
w całość według wzoru

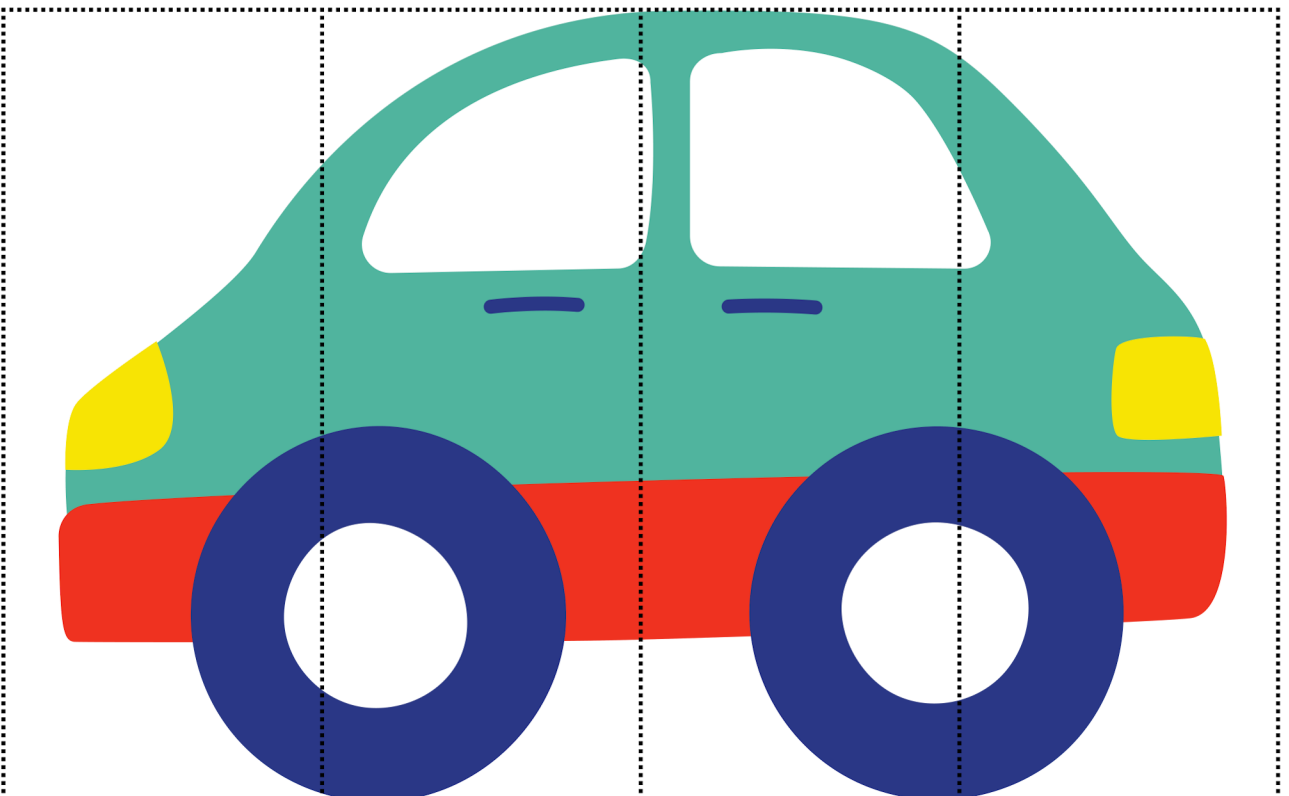
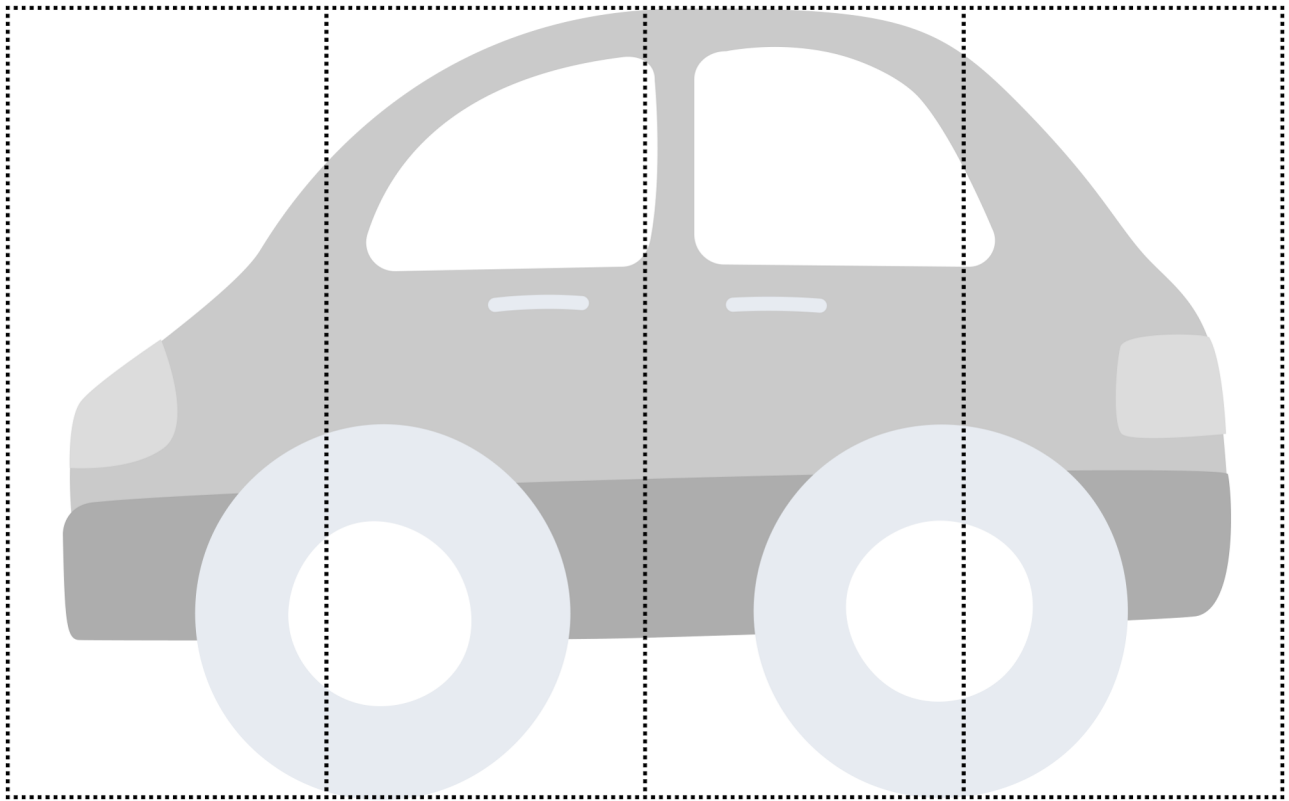

Wytnij kolorowy obrazek i złącz
w całość według wzoru

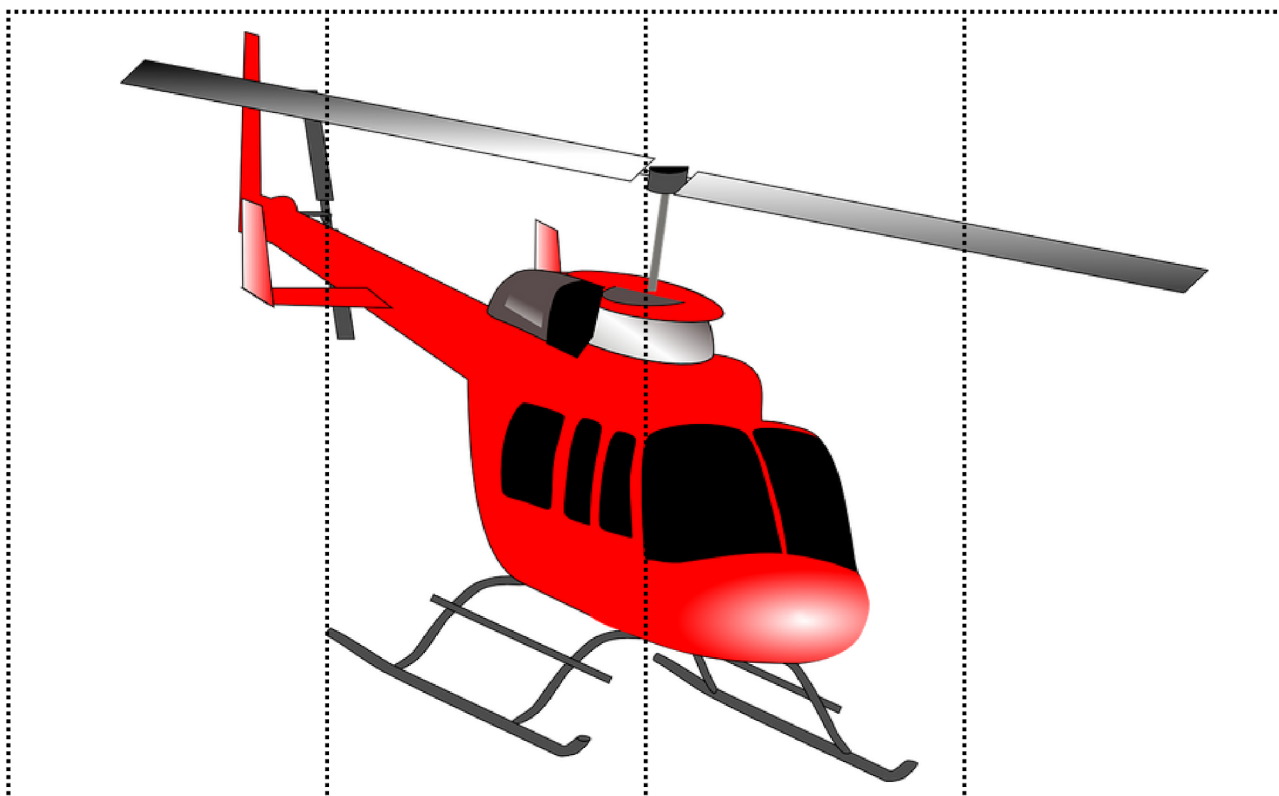
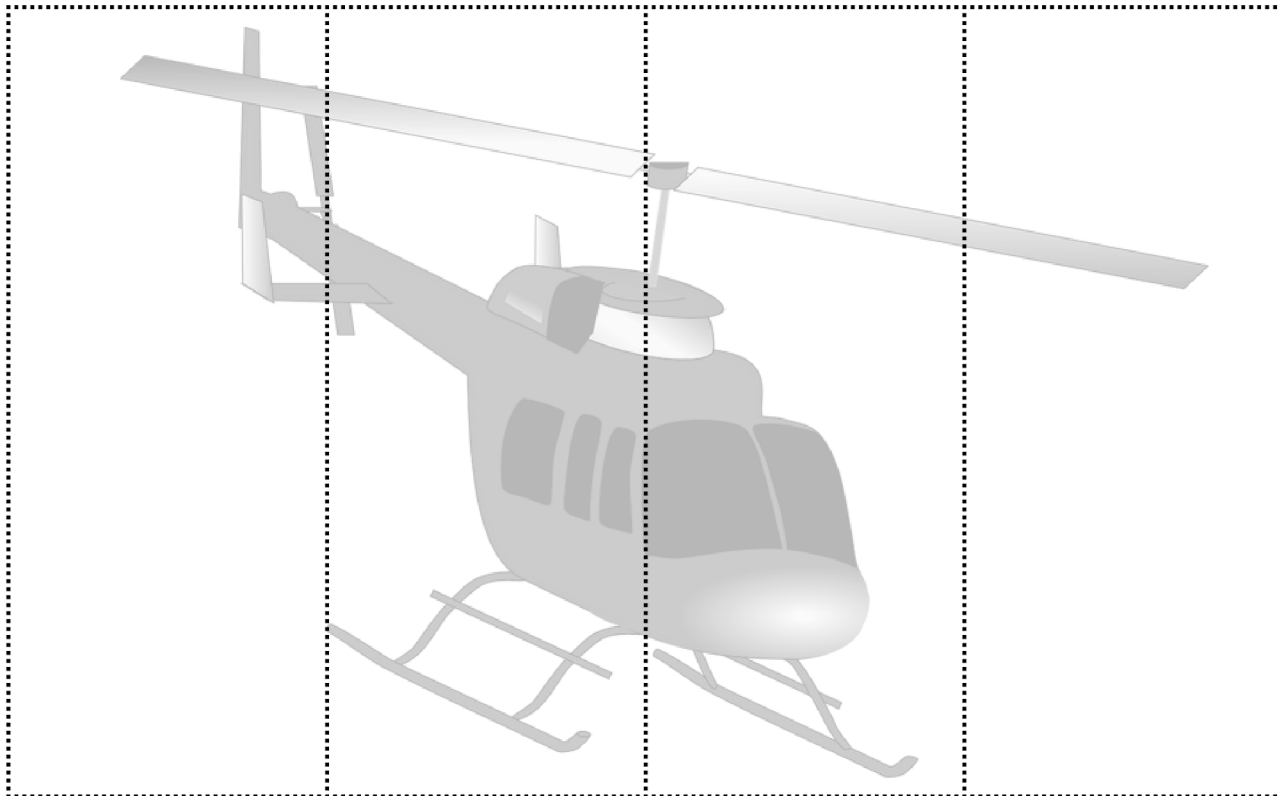

Wytnij kolorowy obrazek i złącz
w całość według wzoru

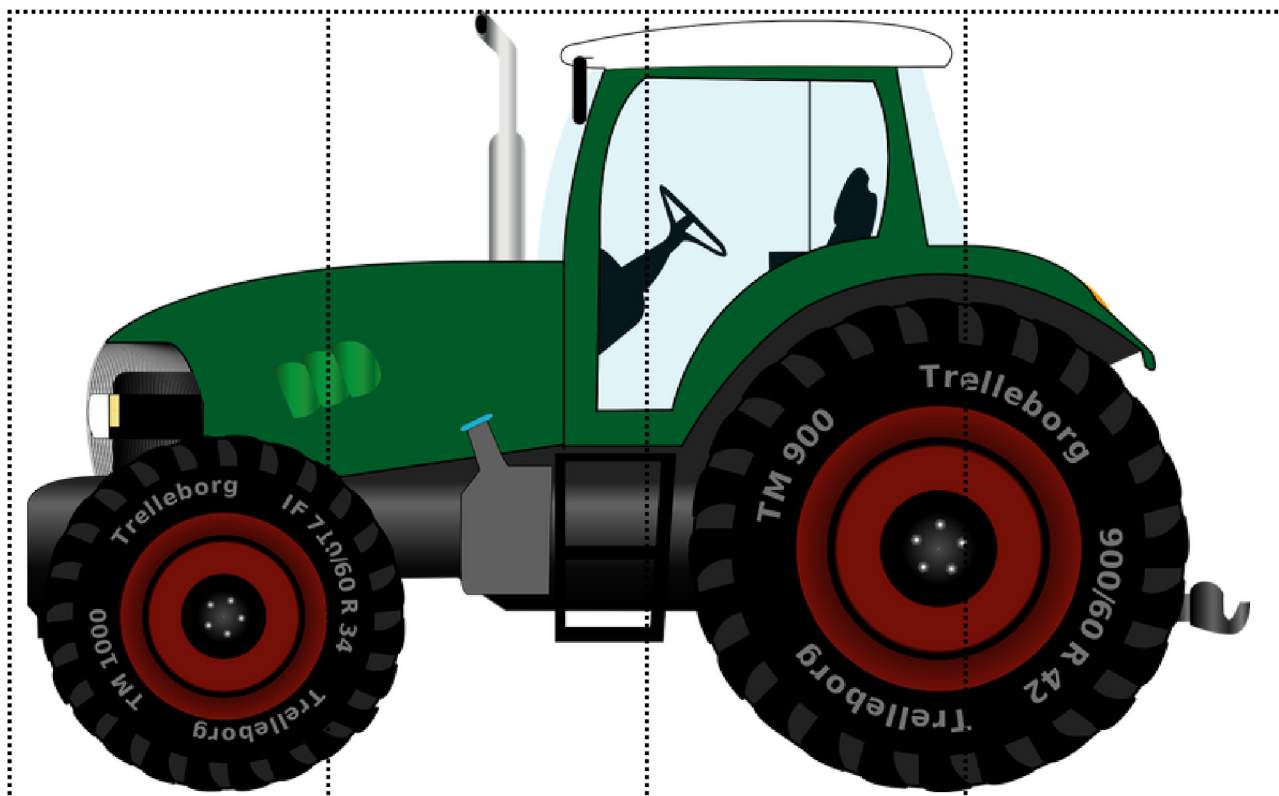
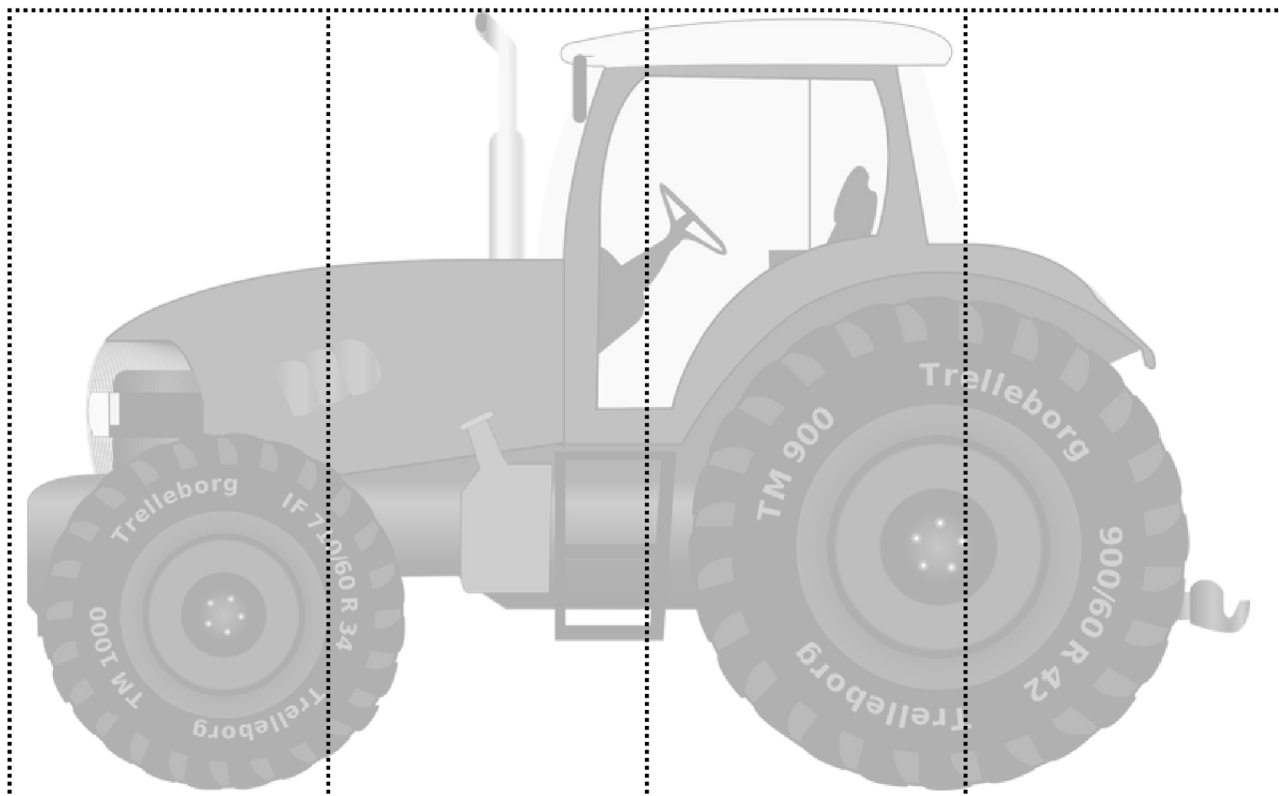

Wytnij kolorowy obrazek i złącz
w całość według wzoru

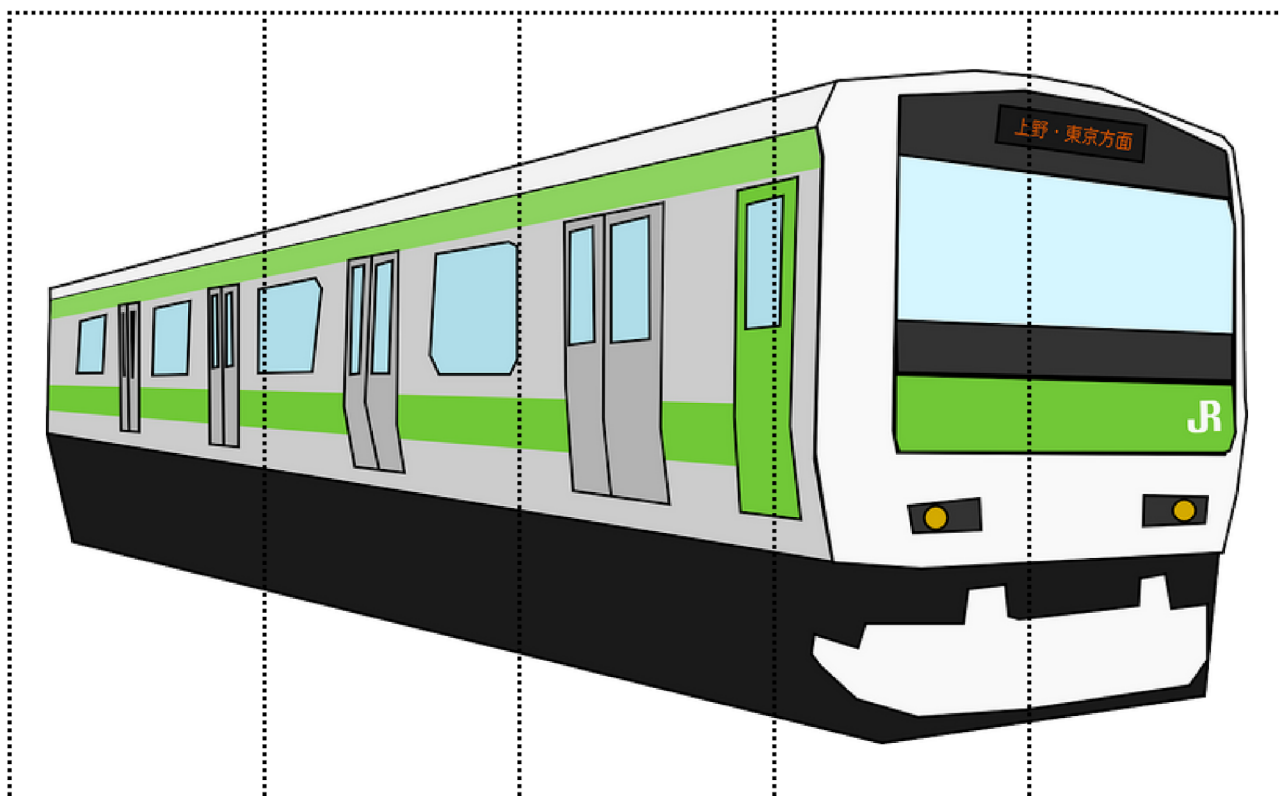
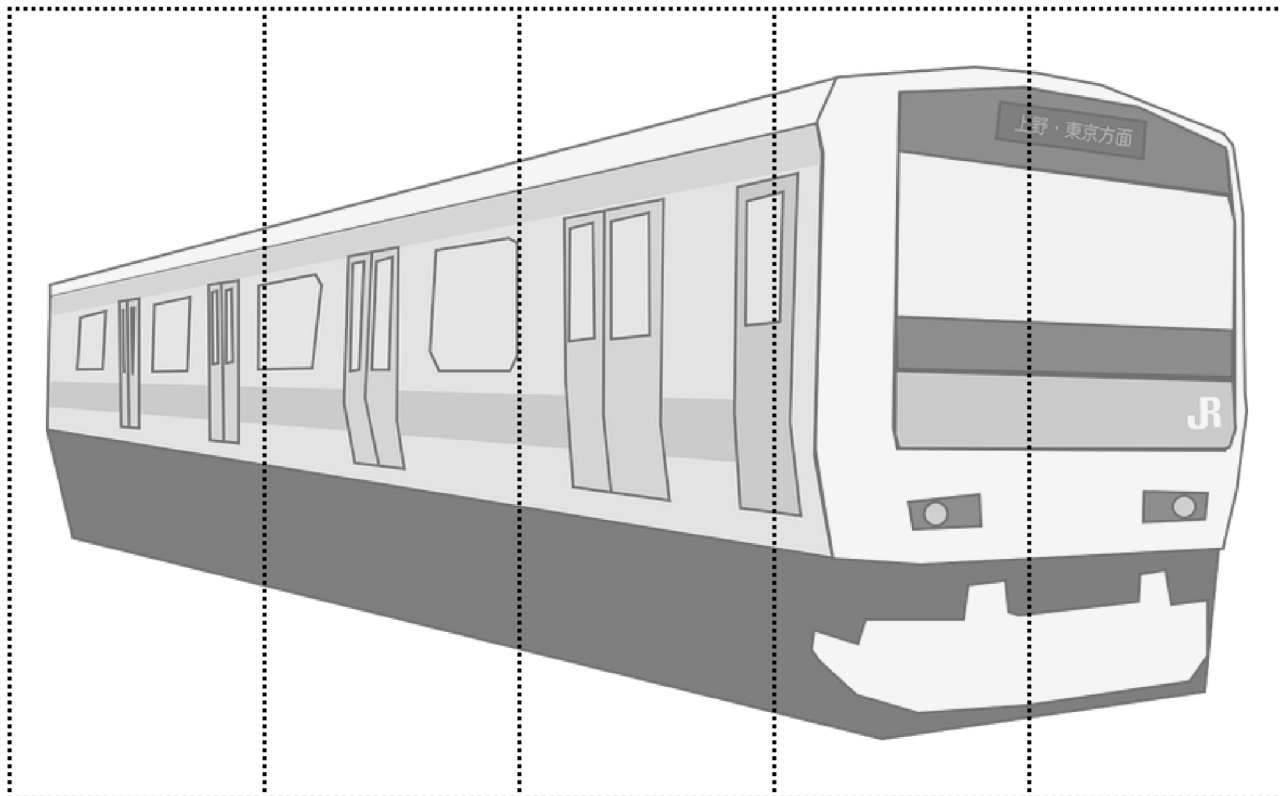

Wytnij kolorowy obrazek i złącz
w całość według wzoru

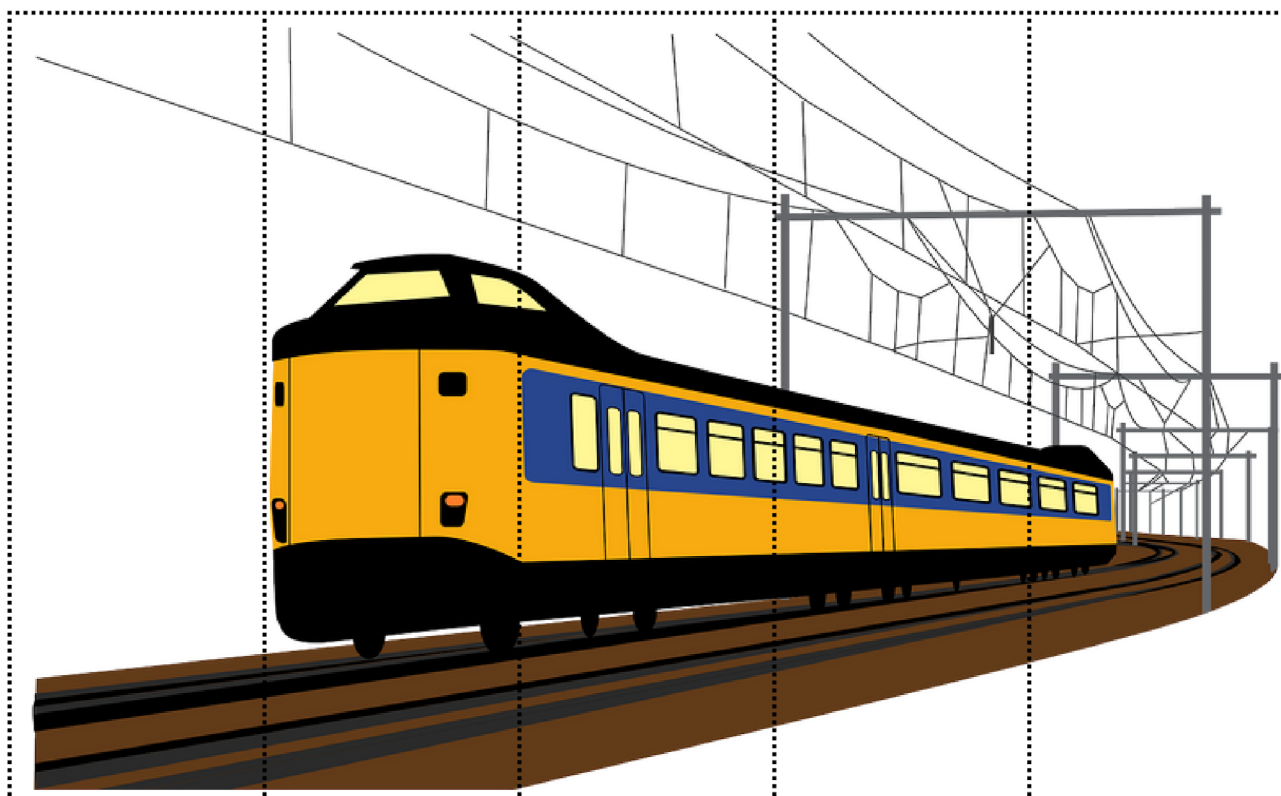
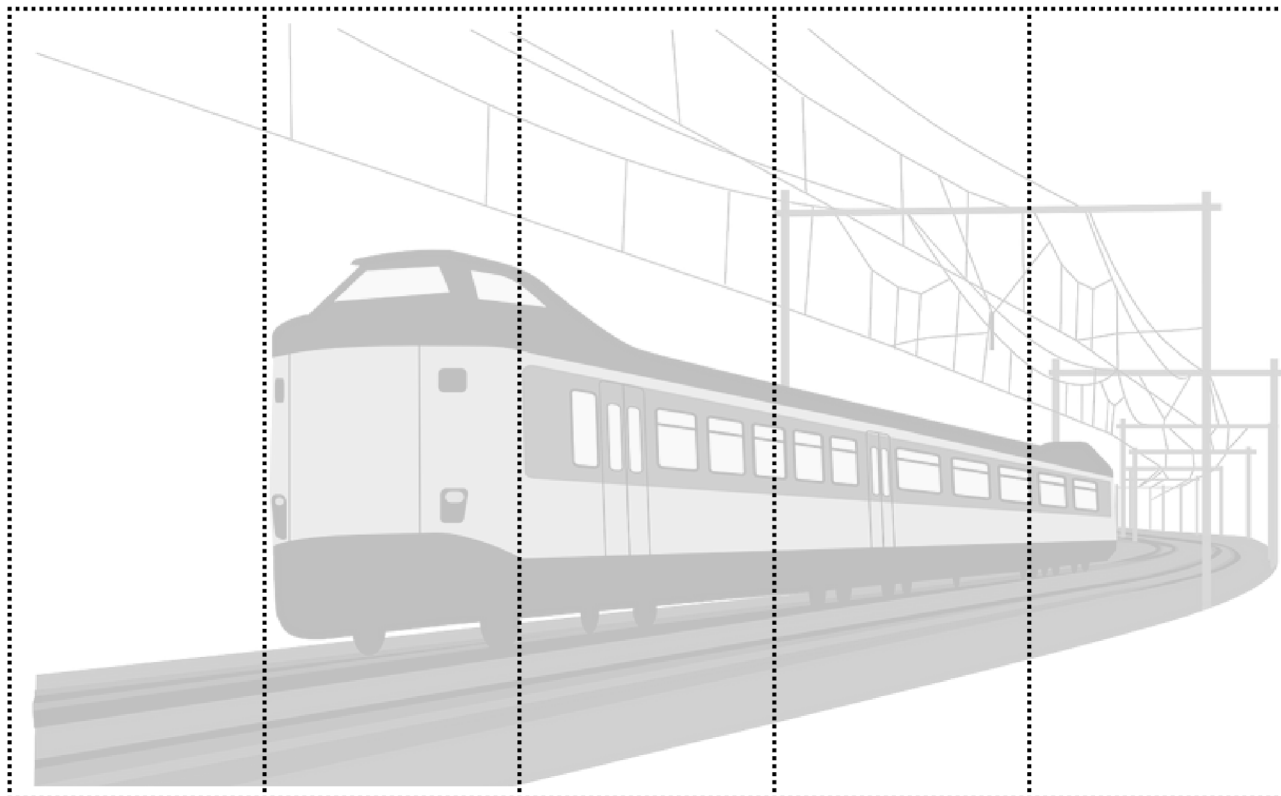

Wytnij kolorowy obrazek i złóż
w całość według wzoru

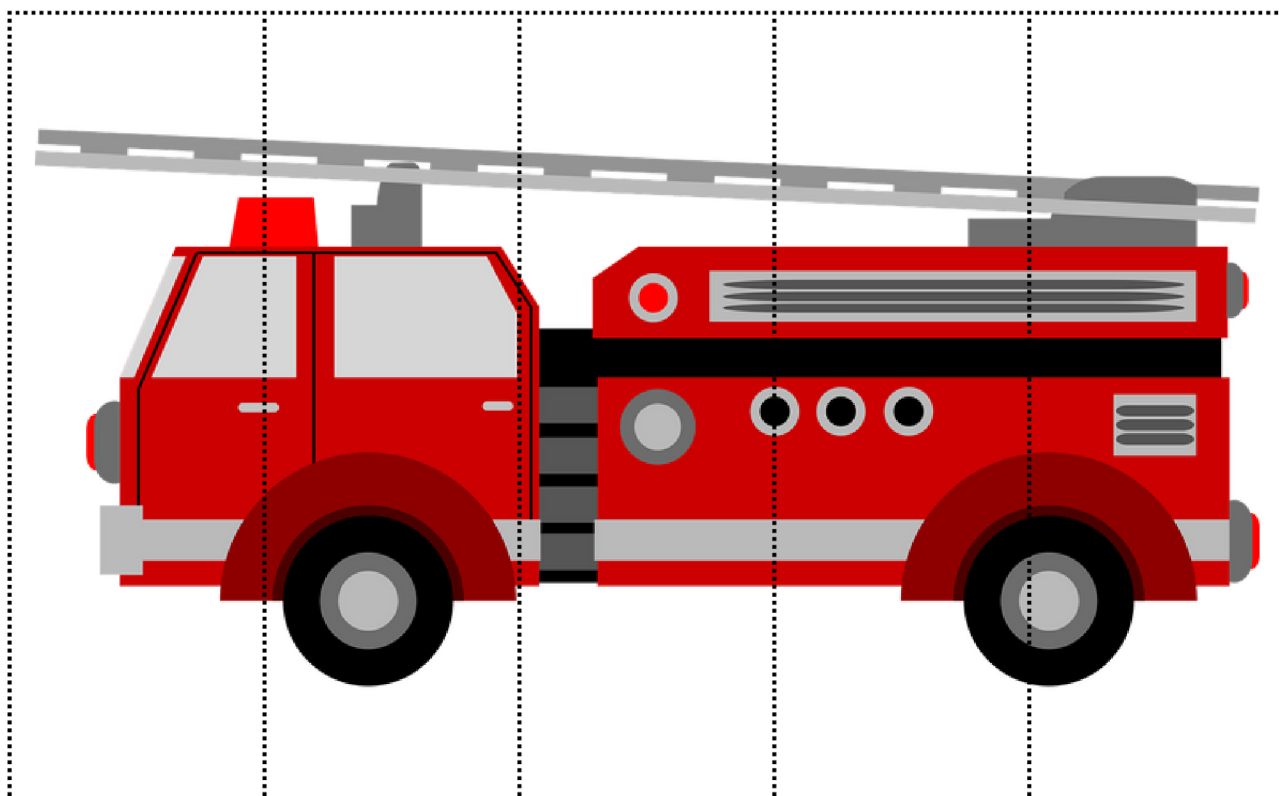
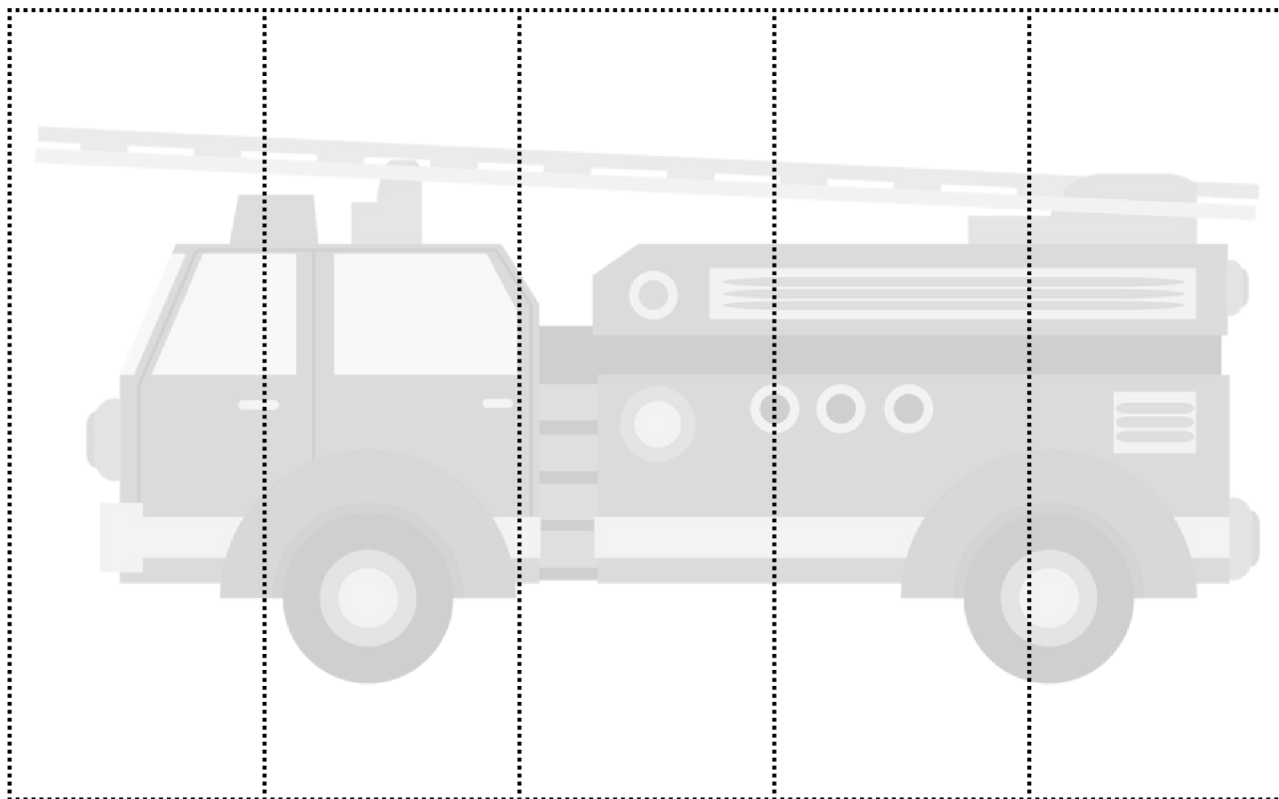

Wytnij kolorowy obrazek i złóż
w całość według wzoru

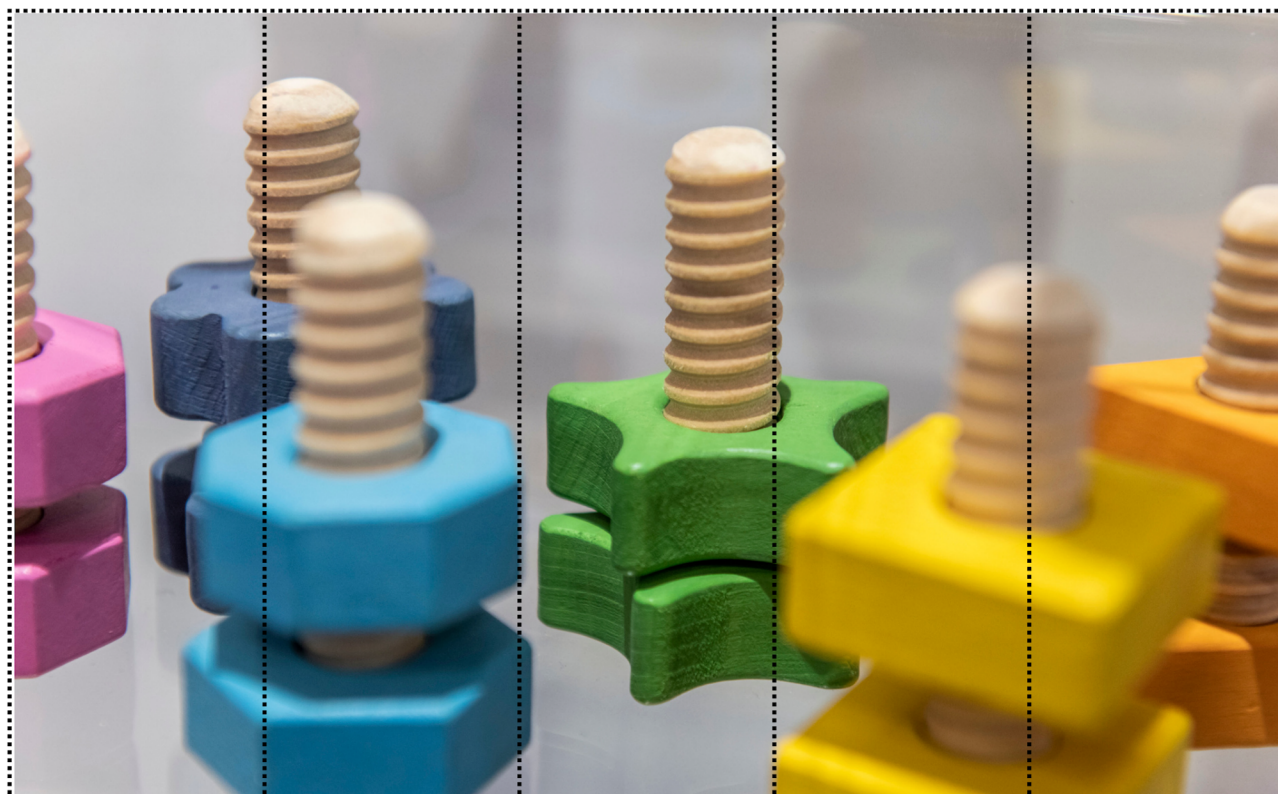
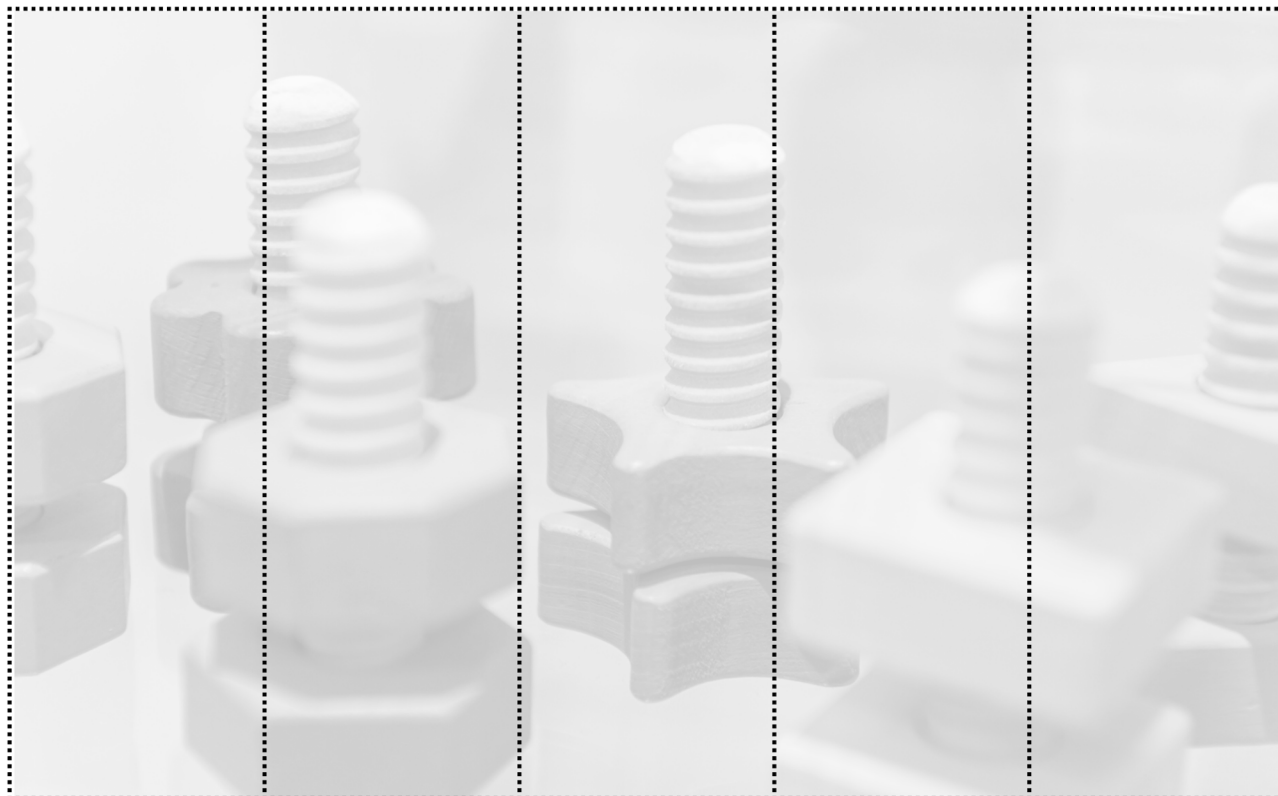

Wytnij kolorowy obrazek i złącz
w całość według wzoru

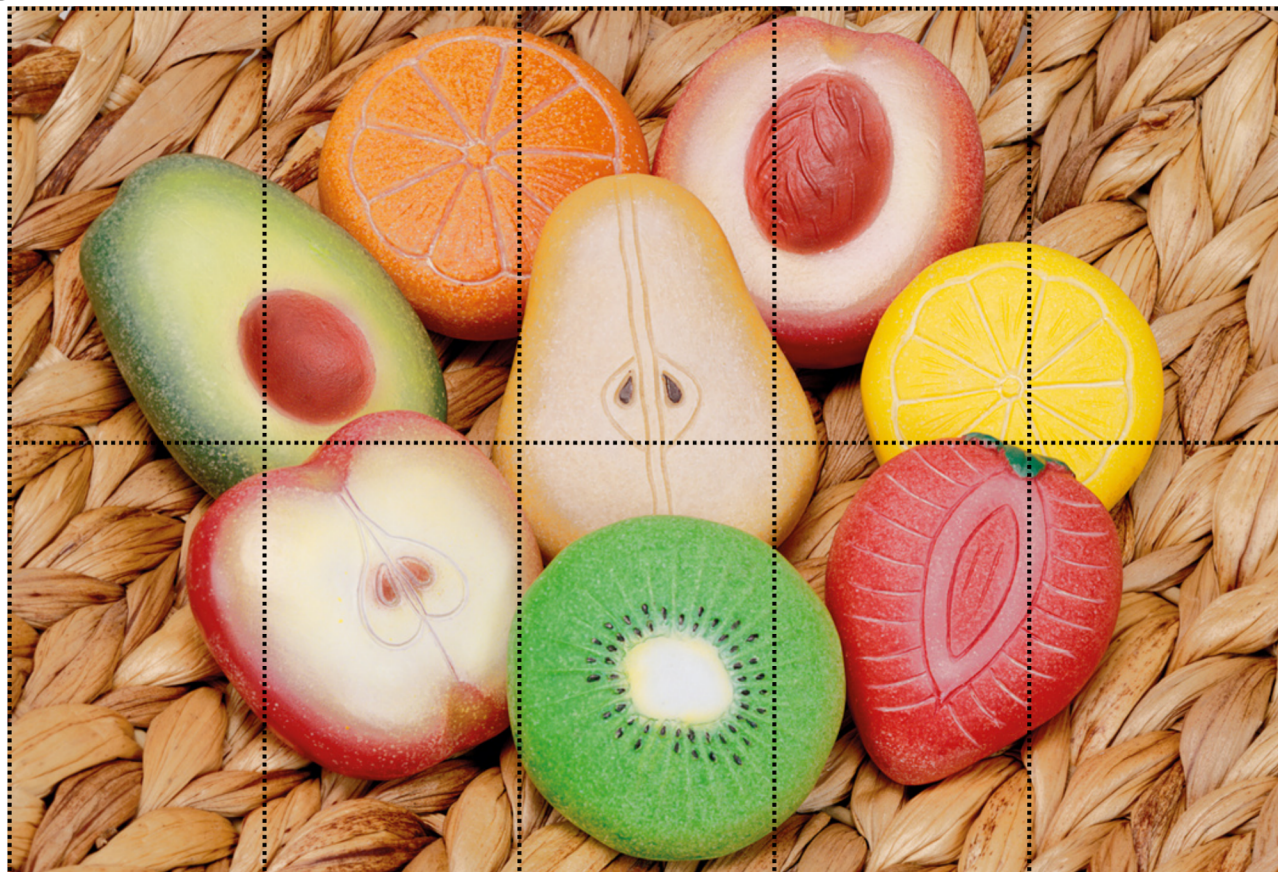
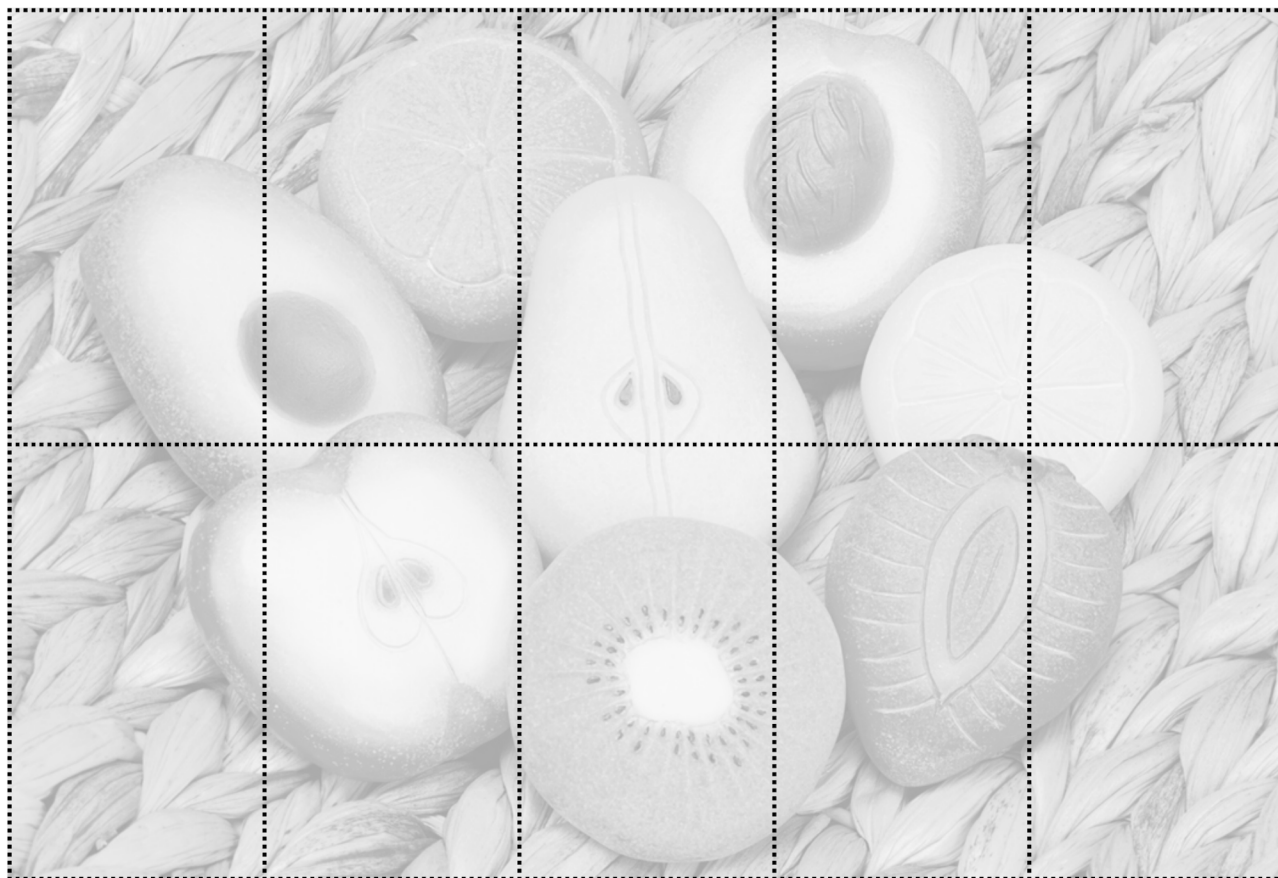



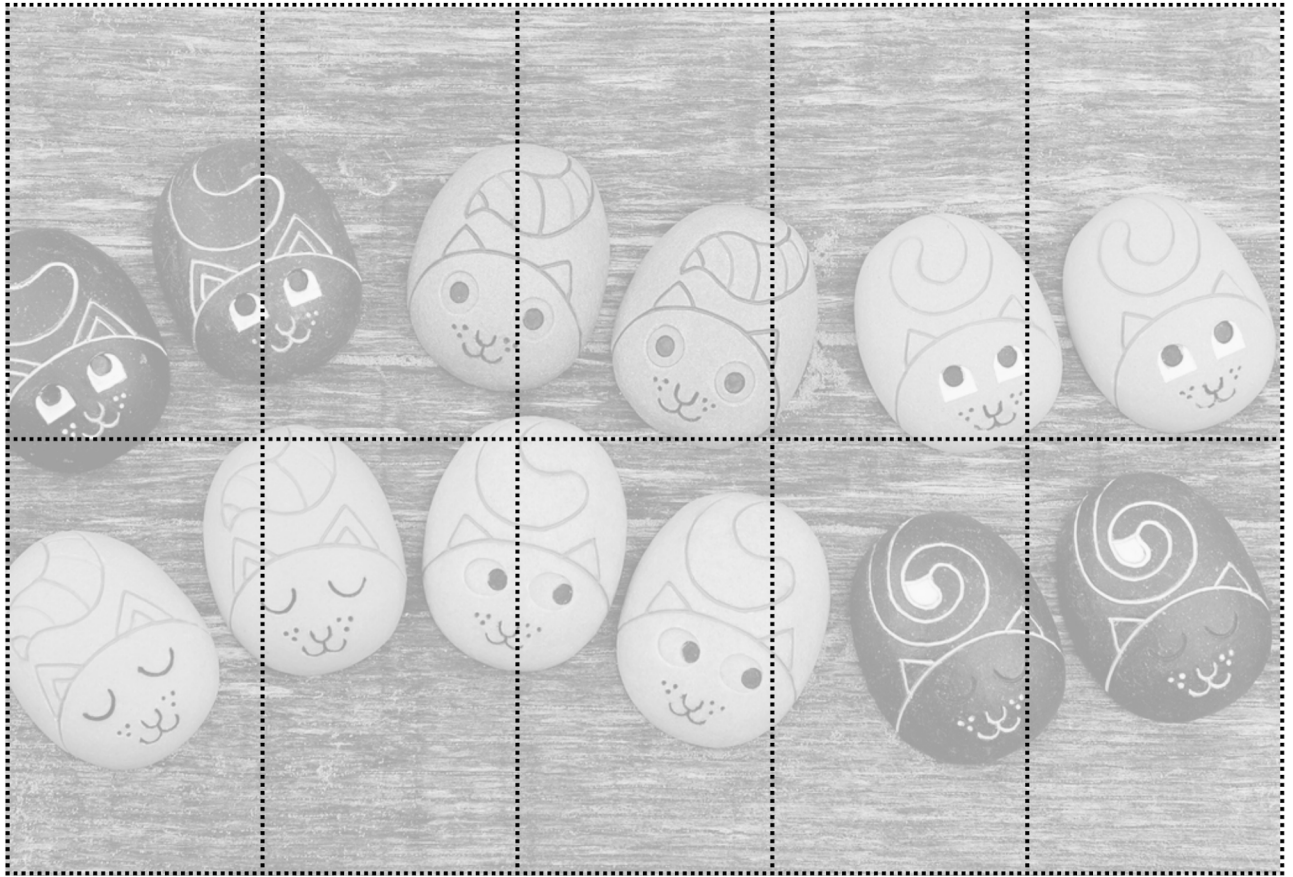



Wytnij kolorowy obrazek i złącz
w całość według wzoru

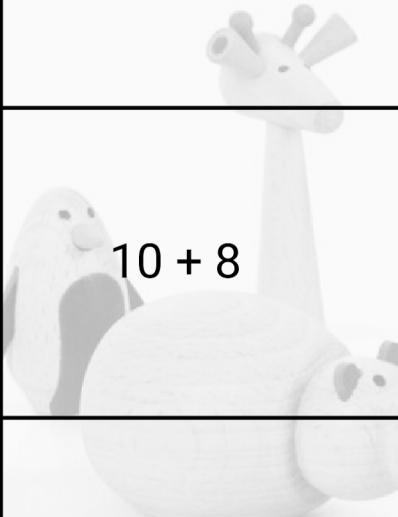

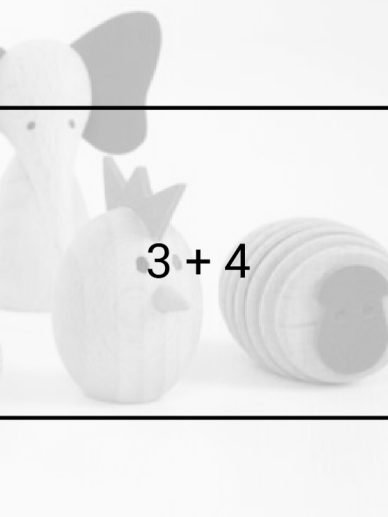
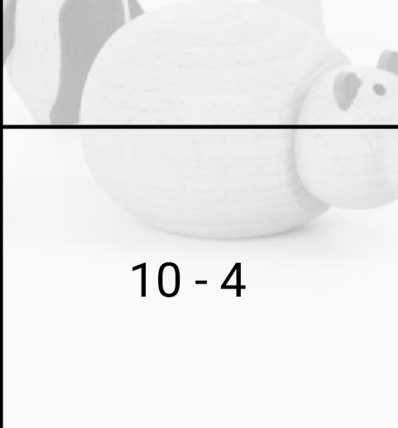
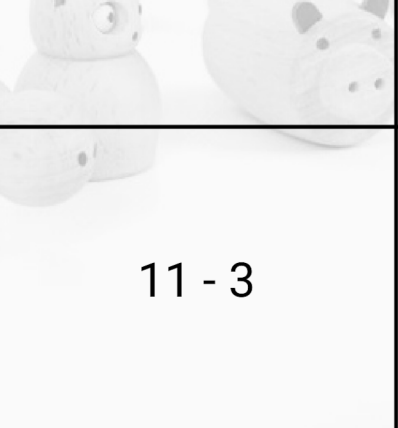
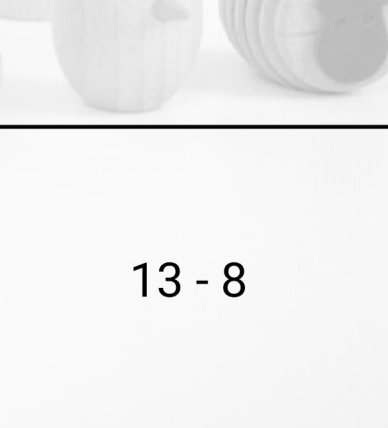
Dopasuj puzzle

Wytnij poniższe kawałki puzzli i wklej kwadraciki z rozwiązaniem we właściwe miejsce

$12 + 3$	$11 - 7$	$3 + 6$
		
$10 + 8$	$7 + 3$	$3 + 4$
		
$10 - 4$	$11 - 3$	$13 - 8$

15	4	9
		
18	10	7
		
6	8	5

Dopasuj puzzle

Wytnij poniższe kawałki puzzli i wklej kwadraciki z rozwiązaniem we właściwe miejsce

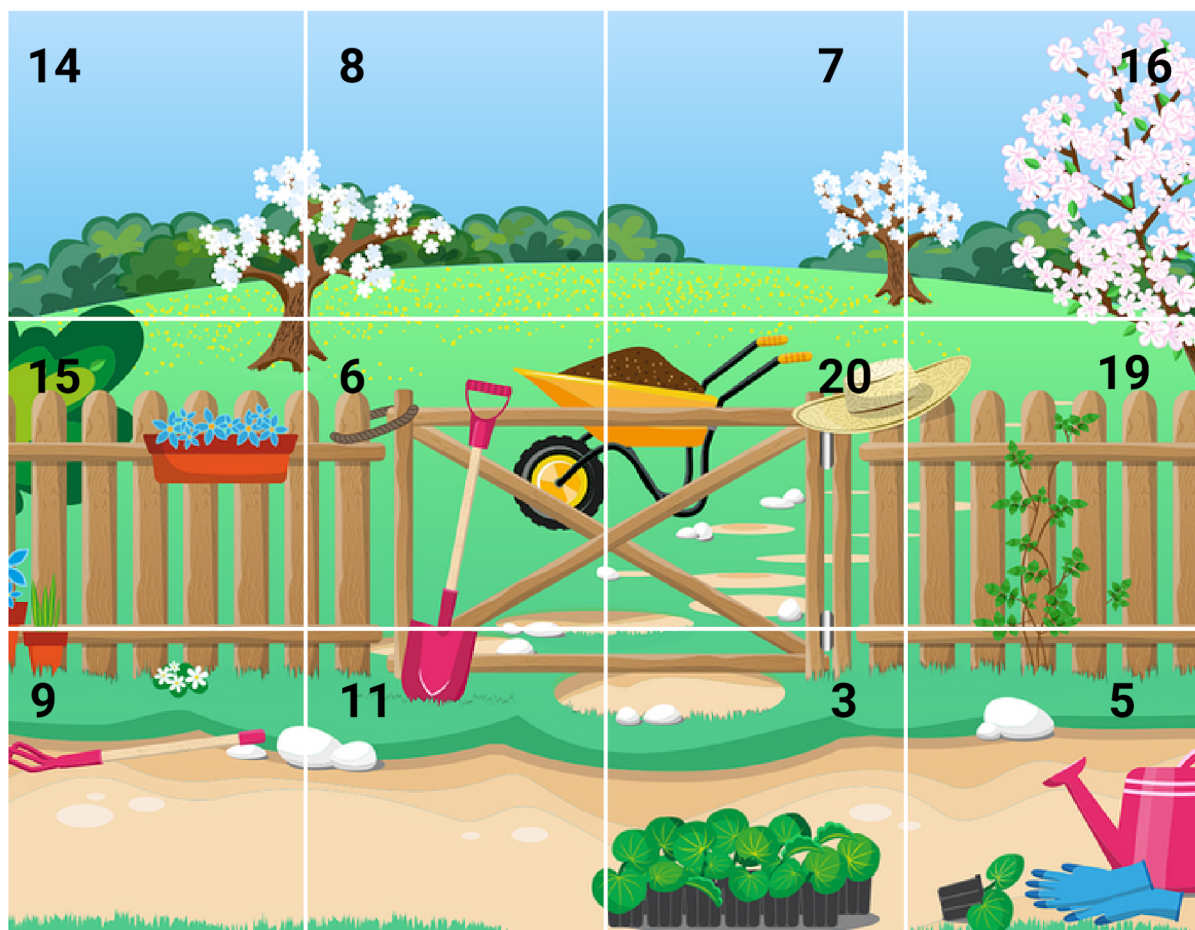

Dopasuj puzzle

Wytnij poniższe kawałki puzzli i wklej kwadraciki z rozwiązaniem we właściwe miejsce

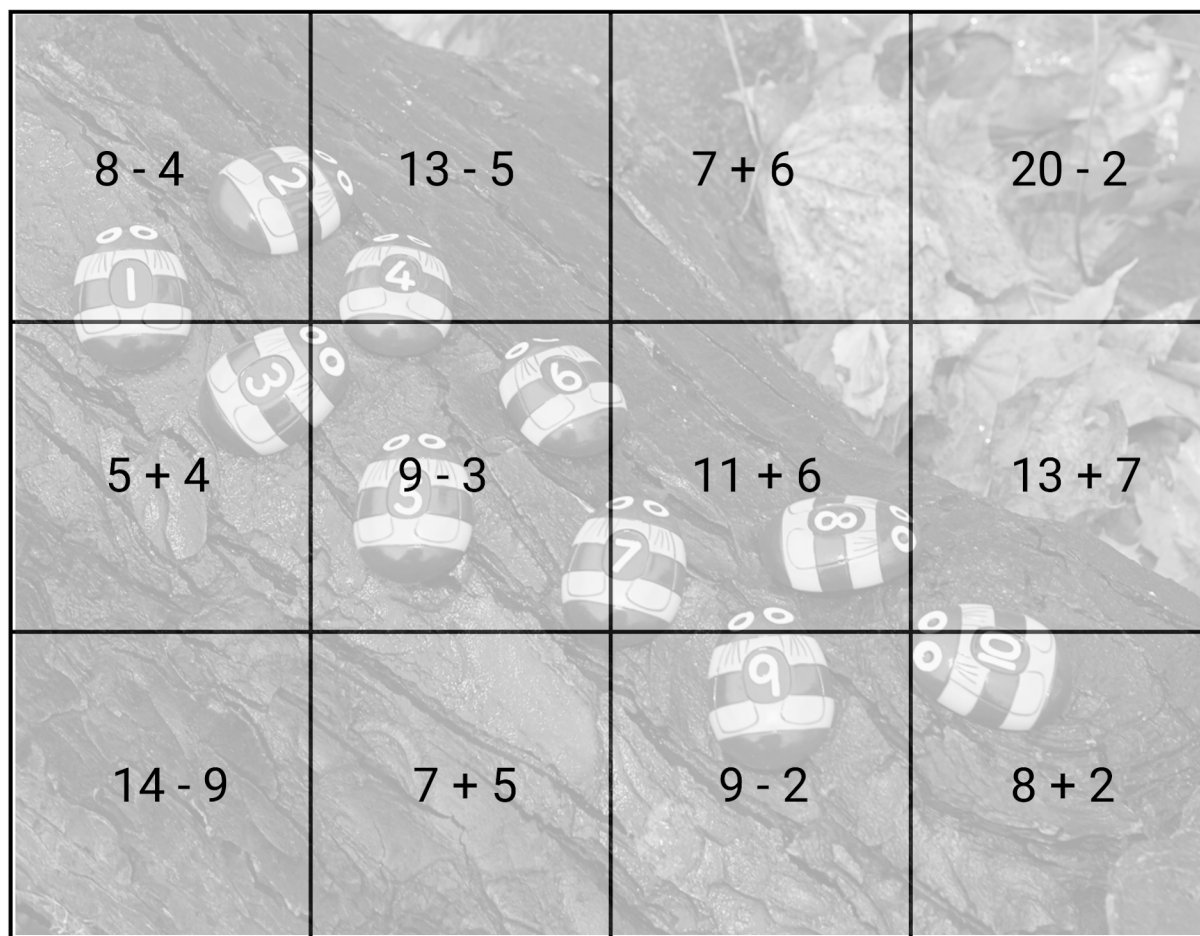

Zobacz różne puzzle edukacyjne



Sensoryczne puzzle XXL - 4 pory roku



Puzzle NAWITO - Owoce



Puzzle NAWITO - Zwierzęta i ich środowiska



Sensoryczne puzzle XXL
- Odkrywamy Ziemię